



STATIC LOAD



45
kN

DYNAMIC LOAD



25
kN

TORQUE at 25MPa



1300
Nm

WEIGHT



26
kg

OILFLOW



20
l/min

COMPATIBILITY



FHL01-A/B-73/25
FHL01B-A/B-73/25

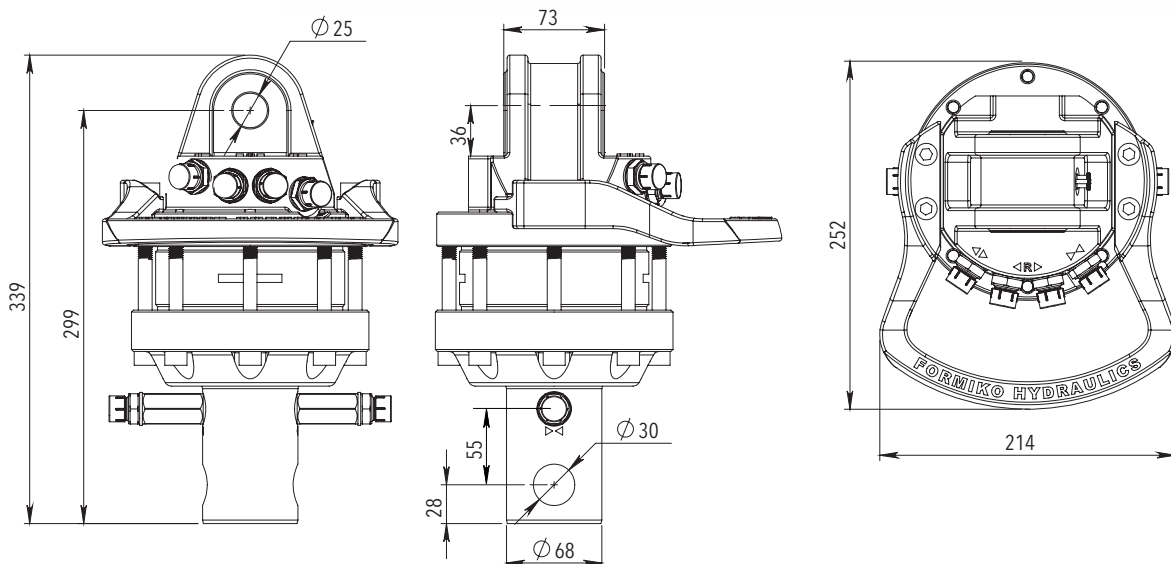

For additional information relating to price levels and technical data, please contact sales@formiko.lv

Formiko Hydraulics Ltd
Dzirciema Str. 119 k-1
Riga LV1055
LATVIA

+371 294 49 552
+371 264 59 383
sales@formiko.lv
www.formiko.lv

Formiko Hydraulics FHR 4.500 are ideal rotator solution for using on medium forestry and agriculture trailers and other applications.



FORESTRY



AGRICULTURE



CONSTRUCTION



GENERAL CARGO



RECYCLING

