



STATIC LOAD



**55**  
kN

DYNAMIC LOAD



**30**  
kN

TORQUE at 25MPa



**1300**  
Nm

WEIGHT



**26**  
kg

OILFLOW



**20**  
l/min

COMPATIBILITY



FHL01-A/B-73/30  
FHL01B-A/B-73/30

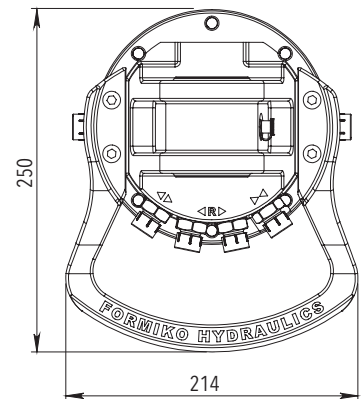
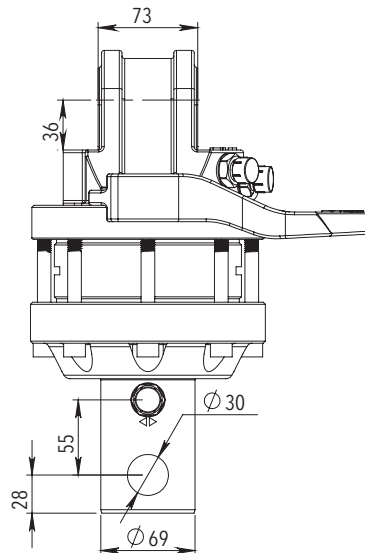
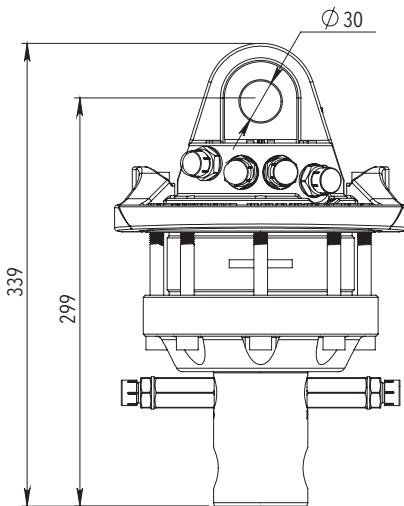

For additional information relating to price levels and technical data, please contact [sales@formiko.lv](mailto:sales@formiko.lv)

Formiko Hydraulics Ltd  
Dzirciema Str. 119 k-1  
Rīga LV1055  
LATVIA

+371 294 49 552  
+371 264 59 383  
[sales@formiko.lv](mailto:sales@formiko.lv)  
[www.formiko.lv](http://www.formiko.lv)

Formiko Hydraulics FHR 5.500 rotators are commonly used with agriculture and forestry equipment for higher loads and intensive use.



FORESTRY



AGRICULTURE



CONSTRUCTION



GENERAL CARGO



RECYCLING

